

# A20 and A25 Series Pressure SWITCHGAGE®

AP-94030B  
Revised 02-02  
Catalog Section 05  
(00-02-0023)



## 2 and 2-1/2 in. (51 and 64 mm) Dial

- Corrosion Resistant Polycarbonate Case
- Indicating Gage and Limit Switch
- Switch Can Activate Alarms and/or Shut Down Equipment
- Critical Pressure Limit Switch Is Visible and Adjustable (Most Models)
- Contact(s) Isolated From Ground

### Description

The A20 Series (2 inch/51 mm dial) and the A25 Series (2-1/2 inch/64 mm dial) SWITCHGAGE® models are diaphragm-actuated, pressure-indicating gages, with built-in electrical switches for tripping alarms and/or shutdown devices.

Ranges are available from 0-15 psi (103 kPa) [1.0 bar] thru 0-400 psi (2.8 MPa) [28 bar].

All models of these rugged, built-to-last instruments are face sealed from the environment by the unique combination of a polycarbonate case and lens, a polished stainless steel bezel and O-ring seals. Ranges above 30 psi (207 kPa) [2 bar] are totally sealed from the external environment (except PE Series).

Accuracy and protection from moderate overpressure is assured by a unique, unitized diaphragm chamber. A built-in pulsation dampener helps eliminate pointer flutter and is removable for cleaning.

For series A20P and A25P, the gage pointer acts as a pressure indicator and as one switch pole which completes a circuit when it touches the adjustable limit contact. Contacts have self-cleaning motion to ensure electrical continuity.

Models A20PE and A25PE have internal snap-acting SPDT switches for three wire control; can be wired to make or to break a circuit.

Gage-only models, without switches (MURPHY-GAGE®) are also available.

### Applications

A20/A25 Series applications include: engines/equipment in Oil Field, Marine, Irrigation, Construction and Trucking Engines for Lube Oil Pressure, Water Pump Pressure, Hydraulic Pressure, Air Pressure, etc.

### Specifications

**Dial:** White on black, dual scale; U.S.A. standard scale is psi/kPa; U.K. standard scale is psi/bar (see How to Order).

**Case:** Polycarbonate/glass filled, corrosion-resistant; steel mounting clamp included.

**Bezel:** Polished stainless steel, standard; others are available (see How to Order).

**Pointer:** Tempered nickel silver; Red tip.

**Lens:** Polycarbonate, high-impact.

**Oil:** Silicon Oil.

**Temperature Range:**

Ambient: -40°F (-40°C) thru 150°F (66°C).

Process: -40°F (-40°C) thru 250°F (121°C).

**Process Connection:** 1/8-27 NPTM brass.

**Sensing Element:** Beryllium copper diaphragm.

**Gage Accuracy (% of Full Scale):**

RANGE	LOWER 1/4	MIDDLE 1/2	UPPER 1/4
≤300 psi (20 Bar)	±3%	±2%	±3%
400 psi (28 Bar)	±3%	±3%	±5%

**Maximum Pressure:** See Pressure Ranges and Factory Settings table on page 2.

**Adjustable Limit Contact (A20P and A25P):**

SPST contact; pilot-duty only, 2 A @ 30 VAC/DC;

Closed when the low limit is met. Open when pointer is in normal operating range.

Contacts are gold flashed silver.

Limit Contact Adjustment: *by a 1/16 in. hex wrench thru 100% of the scale.*

Wiring: A20P: Number 4 screw terminals;

A25P: Number 6 screw terminals.

**Snap-Switch Rating (A20PE and A25PE):**

SPDT, 3 A @ 30 VDC inductive; 4 A @ 125 VAC inductive.

Wiring: A20PE: Number 4 screw terminals;

A25PE: Number 6 screw terminals.

**Unit Weight:** A20 Series: 8 oz. (0.23 kg).

A25 Series Models: 11 oz. (0.31 kg).

**Unit Dimensions:** A20 Series: 3 x 3 x 3 in. (76 x 76 x 76 mm). A25 Series Models: 4-3/4 x 4-3/4 x 2-3/4 in. (121 x 121 x 70 mm).

### Base Models

**A20P and A25P Series SWITCHGAGE®**

The gage pointer makes with an adjustable contact to complete a pilot-duty circuit.

**A20PE and A25PE SWITCHGAGE®**

A20PE (was A20EO) and A25PE (was A25PEO).

Features internal snap-acting SPDT switches, instead of the single pole/pointer contacts. When the switch closes on falling pressure, it becomes Set, as pressure rises the switch Resets (refer to wiring diagram on page 3).

Model A25PE is CSA listed for non-hazardous areas.

Model A25PE-EX is CSA listed for Class I, Division 1, Groups C and D hazardous areas.

**A20PABS and A25PABS SWITCHGAGE®**

Sames as A20P and A25P with internal SPDT snap-switch for pre-alarm.

**A20PG and A25PG MURPHYGAGE®**

Gage without contact(s).



\*\*Products covered by this bulletin comply with EMC Council directive 89/336/EEC regarding electromagnetic compatibility except as noted.

## Dimensions

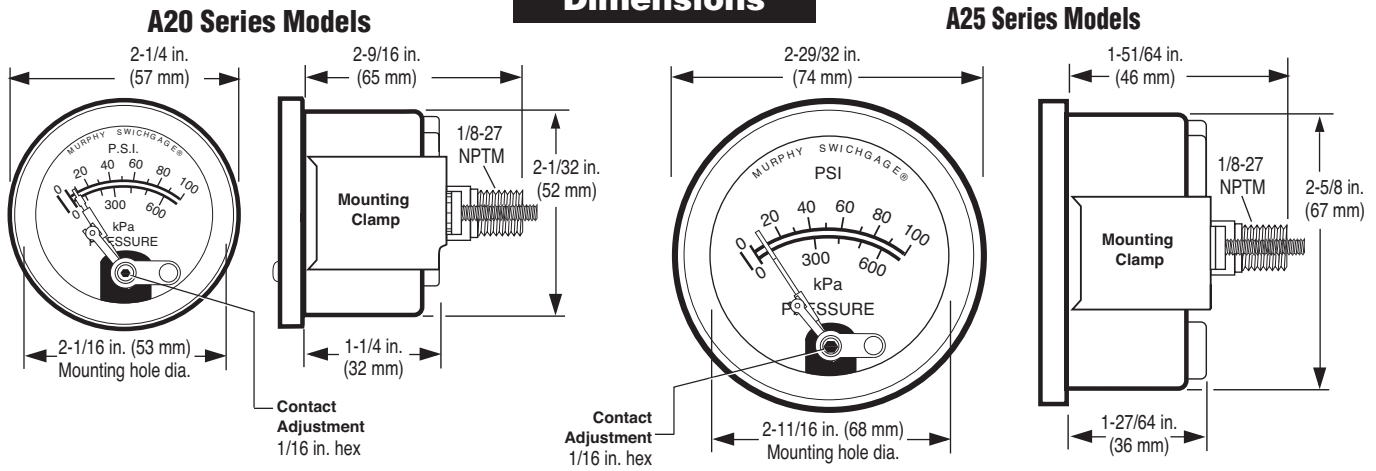

## Pressure Ranges and Factory Settings

### NOTES

- Values in ( ) are mathematical conversions from psi to kPa/MPa—they do not reflect actual second scale range. U.S.A. standard scale is psi/kPa; U.K. standard scale is psi/bar-exact set-point shown. Consult factory for other scales.
- For models A20PE and A25PE; the switch trip point cannot be set at either the low or high extreme of the scale. The trip point must allow for the reset differential.
- For adjustable switch models, the trip point is adjustable **only** over the lower half of the scale.

Ranges Available			Maximum Pressure	Standard Settings			High Settings*			A20PABS and A25PABS Settings					
psi	(kPa)	[bar]		psi	(kPa)	[bar]	psi	(kPa)	[bar]	Low			Alarm†		
0-15	(103)	[1.0]	30 psi (207)	3	(21)	[0.2]	12	(83)	[0.8]	3	(21)	[0.2]	6	(41)	[0.3]
0-30	(207)	[2.0]	60 psi (413)	7	(48)	[0.4]	24	(165)	[1.6]	7	(48)	[0.4]	10	(69)	[0.6]
0-50	(345)	[3.5]	100 psi (690)	10	(69)	[0.8]	40	(276)	[2.8]	10	(69)	[0.8]	13	(90)	[1.0]
0-75	(517)	[5.0]	150 psi (1.0MPa)	15	(103)	[1.0]	60	(414)	[4.0]	15	(103)	[1.0]	18	(124)	[1.5]
0-100	(690)	[7.0]	200 psi (1.4MPa)	20	(138)	[1.5]	80	(552)	[5.5]	20	(138)	[1.0]	23	(159)	[1.5]
0-150	(1.0MPa)	[10]	300 psi (2.1 MPa)	30	(207)	[2.0]	120	(827)	[8.0]	30	(207)	[1.5]	33	(228)	[2.0]
0-200	(1.4 MPa)	[14]	400 psi (2.8 MPa)	50	(345)	[3.0]	150	(1 MPa)	[10]	50	(345)	[3.0]	53	(365)	[4.0]
0-300	(2.1 MPa)	[20]	500 psi (3.4 MPa)	75	(517)	[5.0]	225	(1.6MPa)	[15]	75	(517)	[5.0]	78	(538)	[5.0]
0-400	(2.8 MPa)	[28]	500 psi (3.4 MPa)	150	(1.0 MPa)	[7.0]	300	(2.1MPa)	[20]	75	(517)	[5.0]	150	(1MPa)	[10]

\*\*Low settings for Hi/Lo option same as standard settings. Hi/Lo option available for A20P and A25P models only.

†SPDT Snap-switch is the alarm switch.

## Features

- Process Connection and Port:** Machined from brass bar stock. Together with the diaphragm forms the diaphragm chamber.
- Diaphragm (not shown):** Beryllium copper die formed and heat treated to very close physical and metallurgical specifications.
- Pulsation Dampener:** Designed to minimize undesirable pointer chatter. It is removable for cleaning.
- Dial:** White letters on a black background, dual scale; others available on request—see How to Order.
- Case:** Polycarbonate/glass filled, corrosion resistant; mounting clamp included.
- Bezel:** Polished stainless steel standard, black bezel also available.
- Lens:** Made of high-impact resistant treated polycarbonate.
- Pointer:** Tempered nickel silver for continuity and corrosion resistance—mounted on a machined brass post. Red tip.
- Limit Contact:** SPST contact; N.C. when low limit is met. N.O. when pointer operates above limit.
- Limit Contact Adjustment:** by 1/16 in. hex type wrench thru 100% of the scale. Easy adjustment knob available.
- Electrical Connections:** Number 4 screw terminals for A20 Series; and number 6 screw terminals for A25 Series models.

Typical For All Series (A25P Series Shown)

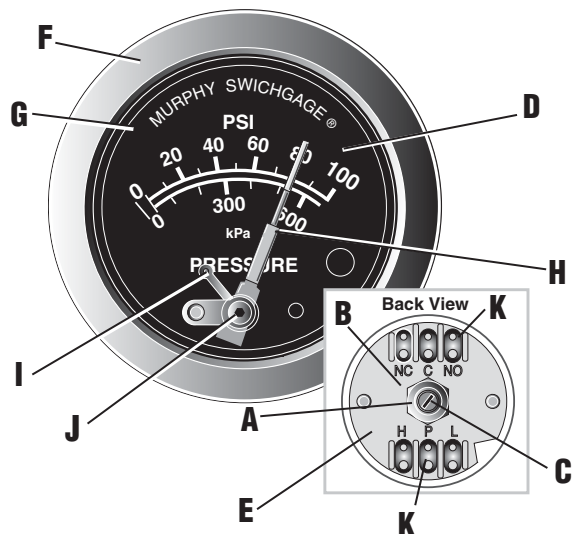

# Magnetic Switch

**INDUCTIVE AND HIGH CURRENT LOADS REQUIRE THE USE OF A MAGNETIC SWITCH.** The SWICHGAGE® contacts are for light-duty electrical switching to operate alarms or control devices. Murphy manufactures the Magnetic Switch for protection of the pilot-duty SWICHGAGE® limit contacts.

TATTLETALE® Magnetic Switches show the cause of shutdown for applications that include: capacitor discharge or magneto ignitions, battery systems and electric motor driven equipment. Typical wiring diagrams are shown below.

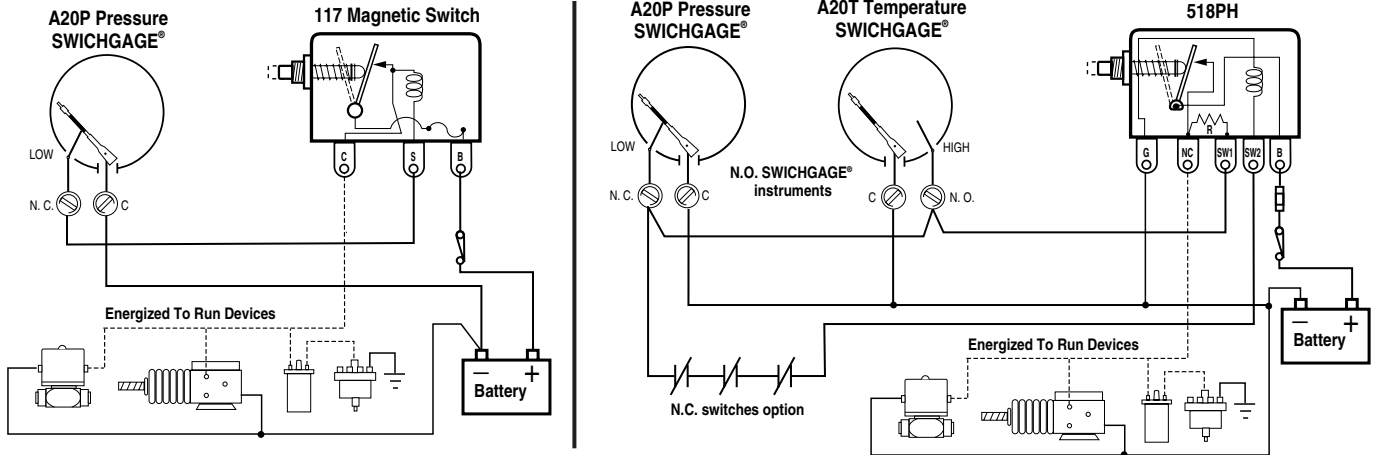

## Pre-Alarm Using A20/A25PABS

The A20PABS and A25PABS features a standard limit contact for equipment shutdown on low pressure. It also has an internal SPDT snap-switch to signal an alarm before shutting down. When the snap-switch trips (preset point), on falling pressure, the switch completes a circuit to activate an alarm. If the pressure continues to fall, the face-adjustable pointer contact will make and the shutdown circuit will be completed (see the typical diagram below for reference). The front contact shutdown limit setting (which is adjustable) and the snap-switch are pre-set at the factory. Refer to "Pressure Ranges and Factory Settings" table on opposite page for settings. For alternative alarm before shutdown, see Magnetic Switch model 760A or 761APH.

The front contact shutdown limit setting (which is adjustable) and the snap-switch are pre-set at the factory. Refer to "Pressure Ranges and Factory Settings" table on opposite page for settings. For alternative alarm before shutdown, see Magnetic Switch model 760A or 761APH.

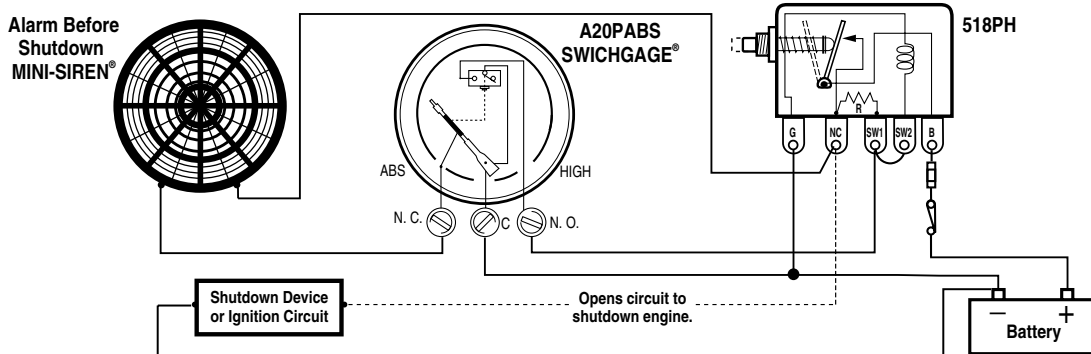

## Typical Internal Wiring Diagrams

Pointer shown in the shelf position. Pointer type contact rating: pilot-duty 2 A @ 30 VAC/VDC resistive. Snap-acting switch rating: 3 A @ 30 VDC inductive, 4 A @ 125 VAC inductive.

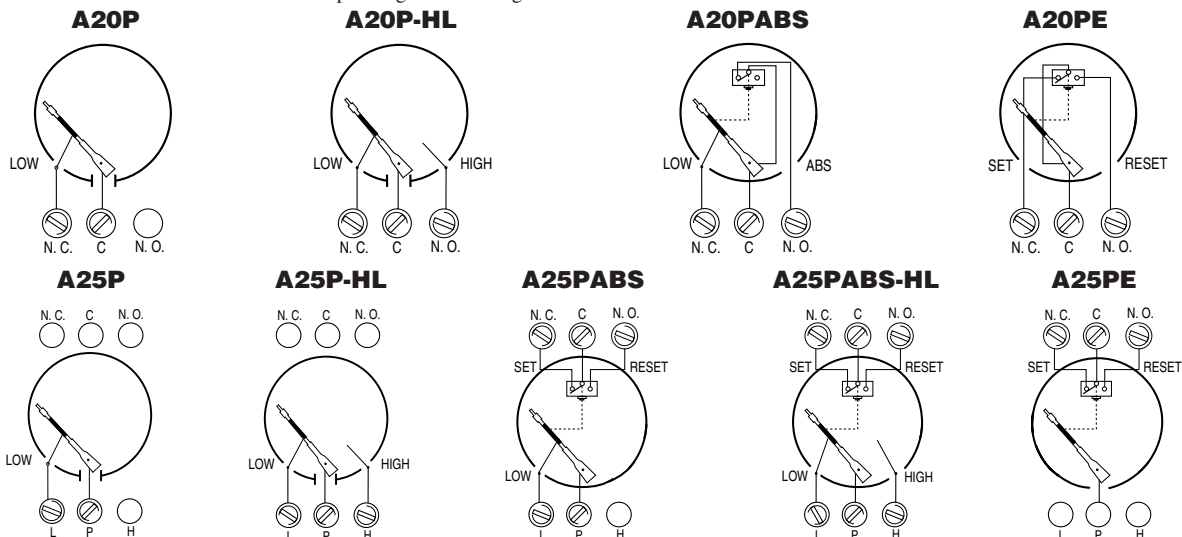

## How to Order

To order, use the diagram below. List options in ascending alphabetical order (A-Z). Example: **A20P-K-100**.

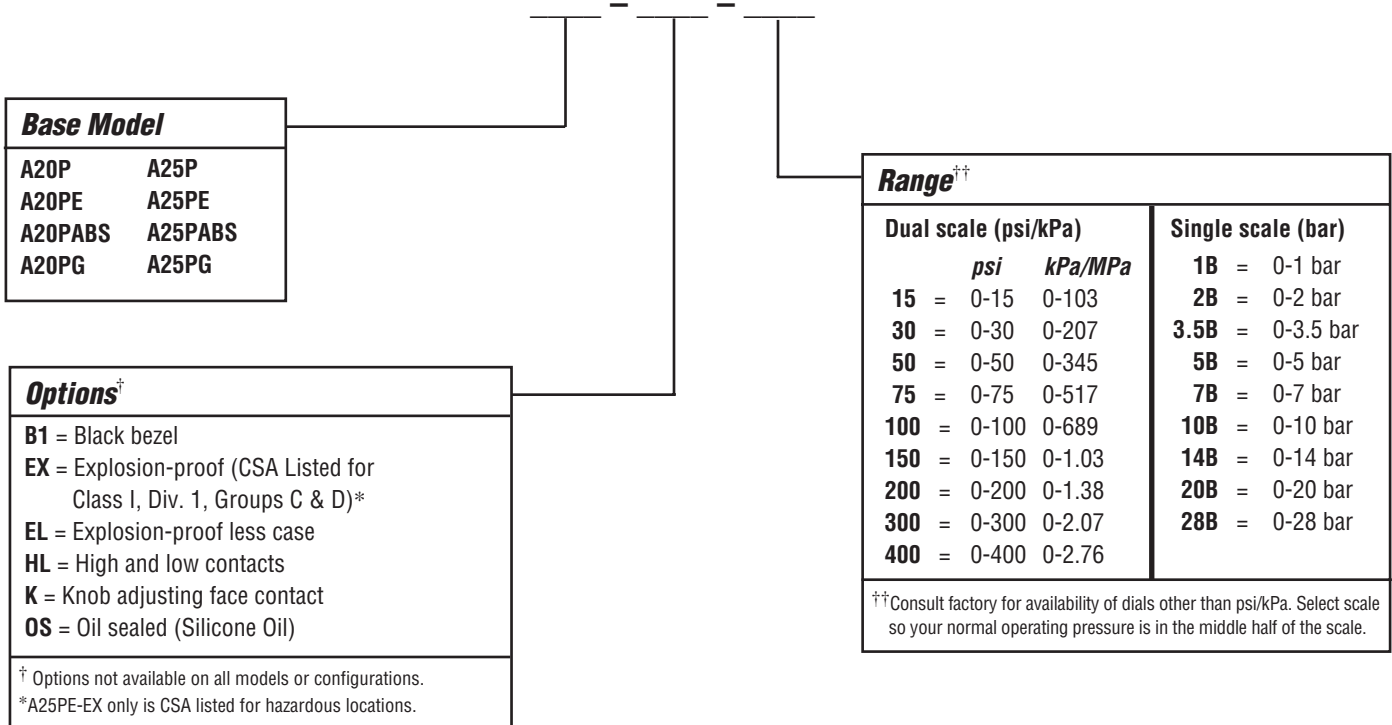

### Illumination – Order Separately

**A20 Series:** Clamp Lite Assembly; 12 V= 05702176; 24 V= 05702177

**A25 Series:** N/A.

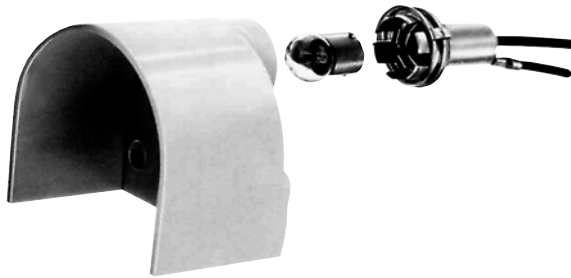

**Find us on the internet:** → http://www.fwmurphy.com

### Warranty

A limited warranty on materials and workmanship is given with this FW Murphy product.  
 A copy of the warranty may be viewed or printed by going to [www.fwmurphy.com/support/warranty.htm](http://www.fwmurphy.com/support/warranty.htm)



**FW Murphy**  
 P.O. Box 470248  
 Tulsa, Oklahoma 74147 USA  
 +1 918 317 4100  
**fax** +1 918 317 4266  
**e-mail** sales@fwmurphy.com  
 www.fwmurphy.com

**CONTROL SYSTEMS & SERVICES DIVISION**  
 P.O. Box 1819; Rosenberg, Texas 77471; USA  
 +1 281 633 4500 **fax** +1 281 633 4588  
**e-mail** sales@fwmurphy.com

**MURPHY DE MEXICO, S.A. DE C.V.**  
 Blvd. Antonio Rocha Cordero 300, Fracción del Aguaje  
 San Luis Potosí, S.L.P.; México 78384  
 +52 444 8206264 **fax** +52 444 8206336  
 Villahermosa Office +52 993 3162117  
**e-mail** ventas@murphymex.com.mx  
 www.murphymex.com.mx

**FRANK W. MURPHY, LTD.**  
 Church Rd.; Laverstock, Salisbury SP1 1QZ; U.K.  
 +44 1722 410055 **fax** +44 1722 410088  
**e-mail** sales@fwmurphy.co.uk  
 www.fwmurphy.co.uk

**MURPHY SWITCH OF CALIFORNIA**  
 41343 12th Street West  
 Palmdale, California 93551-1442; USA  
 +1 661 272 4700 **fax** +1 661 947 7570  
**e-mail** sales@murphyswitch.com  
 www.murphyswitch.com

**MACQUARRIE CORPORATION**  
 1620 Hume Highway  
 Campbellfield, Vic 3061; Australia  
 +61 3 9358 5555 **fax** +61 3 9358 5558  
**e-mail** murphy@macquarrie.com.au



*In order to consistently bring you the highest quality, full featured products, we reserve the right to change our specifications and designs at any time.*